

# KNL Introduction

Ver. 2011\_0308



# Products Line UP

- ▶ **Total Digital Signage Solution**
  - 1) Digital Signage Terminal
  - 2) Manager Software
  - 3) Integration of AD System
  - 4) Contents of Advertisement

32" ~ 82" Signage  
 UBC Series S/W  
 Customized  
 Advertising  
 Contents & System



- ▶ **TV Solution**
  - 1) DPF TV, LCD TV
  - 2) LCD Monitor
  - 3) Mirror TV Solution

15", ~55"  
 22", 24", 32"  
 15" ~ 55"



- ▶ **Digital Photo Frame**
  - 1) Standard DPF
  - 2) Accessory DPF
  - 3) Wi-Fi DPF / Wireless Monitor

1.8"  
 8.0", 8" Wi-Fi  
 22", 22" Wi-Fi



# 1. Introduction of ATDS Solution

Display Operation Division

Digital Signage

1. Introduction of ATDS Solution



Delivers quickly and efficiently the promotion of event and new product to the clients for each place/time , unlike the existing advertisement or promoting method.

And also, provides state of the art high-definition promoting system when and where easily by central management system that is loaded with strong software engine and security function based on network technology.

# 2. Stand Type Digital Signage

Display Operation Division

Digital Signage

2. Indoor Digital Signage

Example of 3 level partition of the vertical display



Flash, Movie

Flash, Video, TV

Text, JPEG, BMP



Stand Type



Mirror Type



Wall Mount Type



Installation Example

# 3. Stand Type Digital Signage

Display Operation Division

Digital Signage

3. Outdoor Digital Signage

## 3-1. Introduction of Outdoor Digital Signage

Light Panel  
Commercial panel

Flash, Video, JPEG,  
PC

32" Double-faced  
Outdoor Signage(1500nit)

Can help to advertise outside environment by adopting LCD which is the most brightest of **1500nits**. **IP-56**(International Protection Standard)standard satisfaction (The best waterproof/dustproof to withstand harsh outside environment) .

Guarantee of the product safety by adopting aluminum frame and full-scale tempered glass.

Can play the image freely in server, internal memory or PC that are connected by LAN/WLAN in real time anywhere around at store, school, hospital, restaurant, public places and so on.



Air Conditioner(Optional)

Touch Panel(Optional)

# 3. Stand Type Digital Signage

Display Operation Division

Digital Signage

3. Outdoor Digital Signage

## 3-2. Features of Outdoor Digital Signage

**IP-56 Satisfied International protection standard**



Shower booth Test



IP56(Certificate of Test)



450Nits(Normal TV)



Digital Signage Brightness



700Nits (Indoor)



1,500Nits (Outdoor)

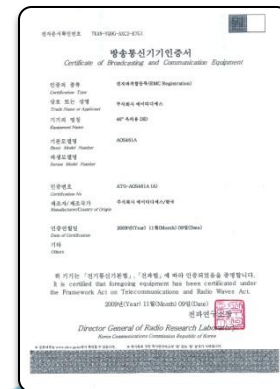

EMC Registration

# 3. Stand Type Digital Signage

Display Operation Division

Digital Signage

3. Outdoor Digital Signage

## 3-3. Product Line-Up

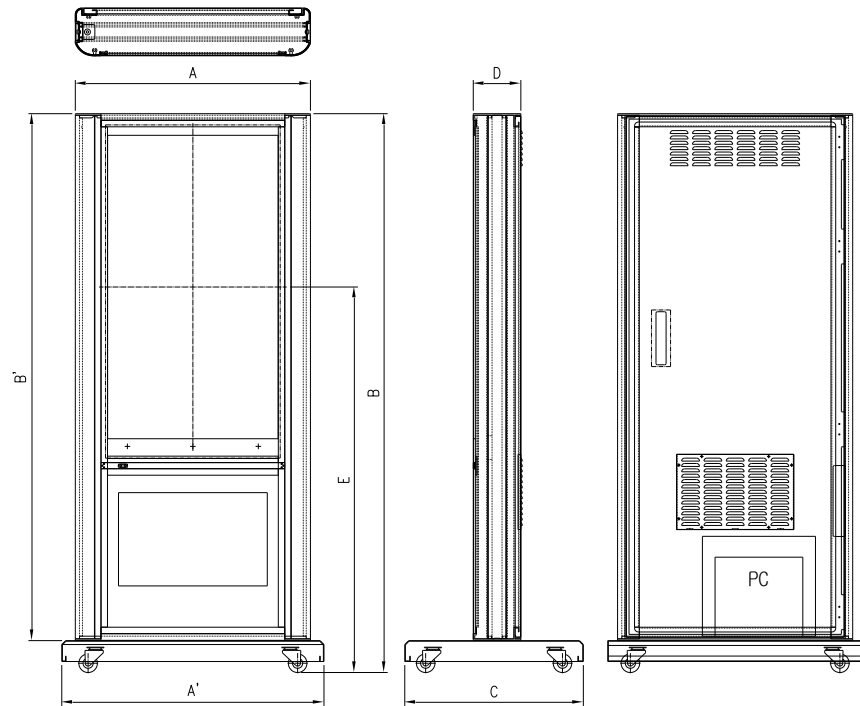

( UNIT : mm )

	A	A'	B	B'	C	D	E	Packing size	Total Weight
40inch	714	805	1793	1696	580	160	1278.6	1840*935*680	108 kg
46inch	790	881	1875	1768	600	160	1293.5	1920*1030*730	117 kg
46inch	879	970	1875	1768	600	160	1276.5	1920*1030*730	122 kg
52inch	870	961	1995	1888	650	160	1346.8	2040*1110*780	128 kg
57inch	946	1037	2130	2023	680	160	1413.8	2175*1320*870	139 kg

\* Products dimension and appearance are subject to change without notice for improvement.

# 4. Wall Mount Type Digital Signage

Display Operation Division

Digital Signage

4. Wall Mount

## 4-1. Products Line-Up

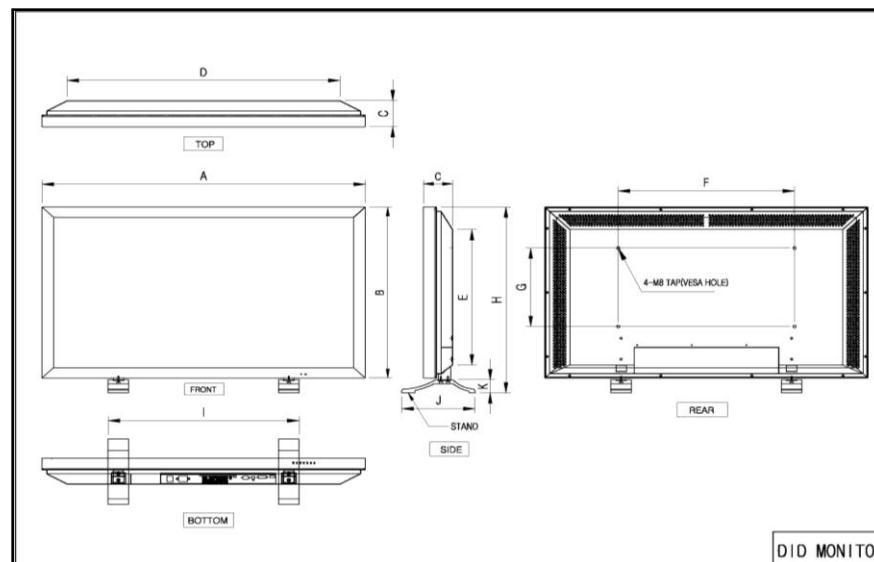

	A	B	C	D	E	F	G	H	I	J	K	Packing size
40inch	967.5	580	96.2	860	472.3	400	200	637.5	470	250	50	1115*295*735
46inch	1100.4	653.6	98.7	931.9	520.4	600	300	710.6	650	250	50	1250*295*805
52inch	1240	736	101	1066	599.5	600	300	796.8	650	250	50	1390*295*890
57inch	1365.8	816.7	102.3	1204.6	689.6	700	400	876.2	770	250	50	1515*295*970
70inch	1666.6	988.6	135	1497.2	848.9	800	600	1056.3	900	280	60	1810*370*1130
82inch	1916.6	1127.6	137.2	1786.2	1006.1	800	600	1200.6	900	280	60	2060*370*1270

\* Products dimension and appearance are subject to change without notice for improvement.

# 5. Multi Vision

Display Operation Division

Digital Signage

5. Multi Vision

## 5-1. Multi Vision Introduction



Super Slim Bezel Design  
 Normal Multi Vision : 2 cm  
 Hyper Super Slim : **0.73 cm(3.6mmX2)**

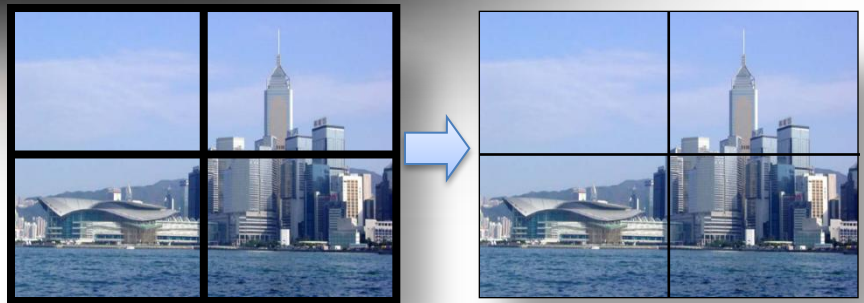

- ◆ **Super Slim Bezel distance**  
: The establishment of best condition for Multi-Display formation
- ◆ From 1X1 to 1X5, can be applied to every display combination

# 6. Sun Light Readable LCD

Display Operation Division

Digital Signage

6. Sun Light Readable LCD

## 6-1. Sun Light Readable Solution

BLU Brightness Up + A/R Coating + Optical Bonding

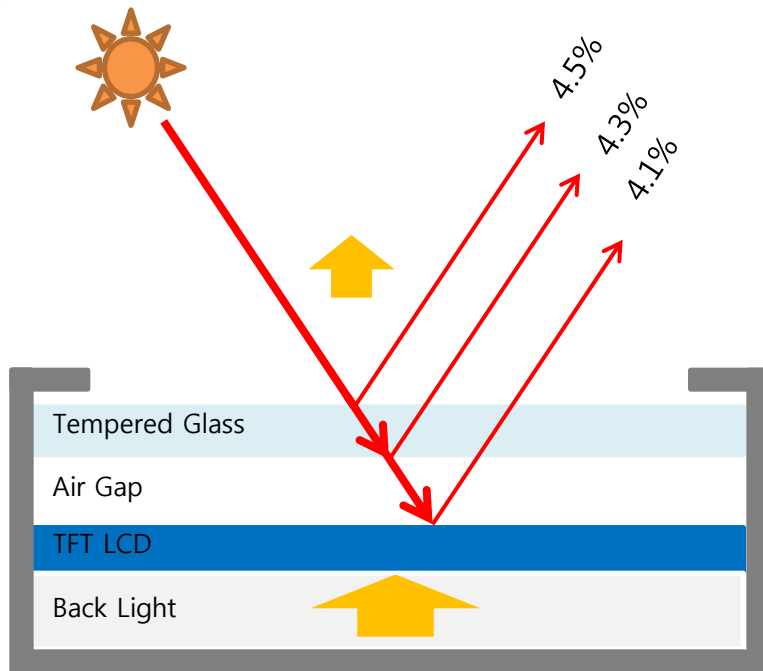

Normal LCD

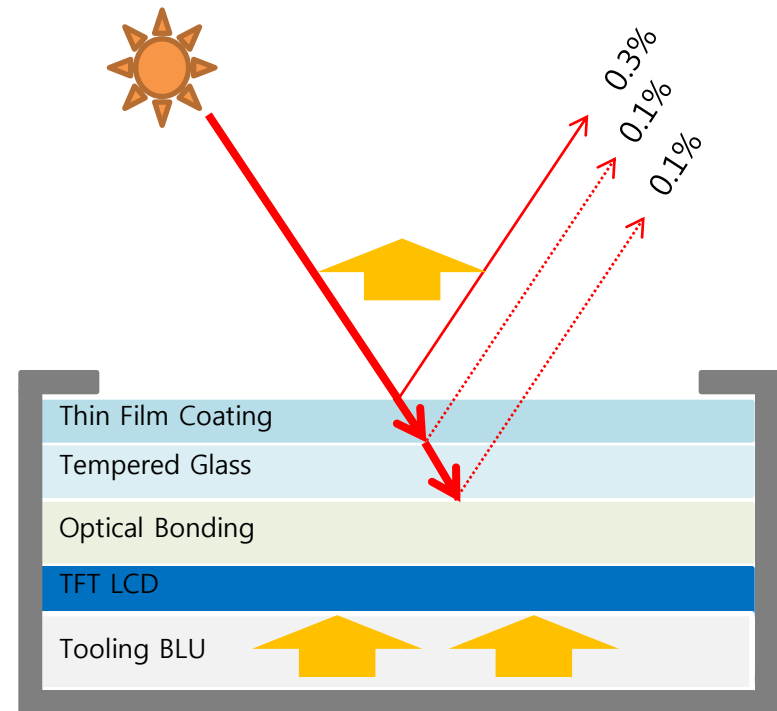

Sun Light Readable LCD

# 6. Sun Light Readable LCD

Display Operation Division

Digital Signage

6. Sun Light Readable LCD

## 6-2. Comparison of LCD

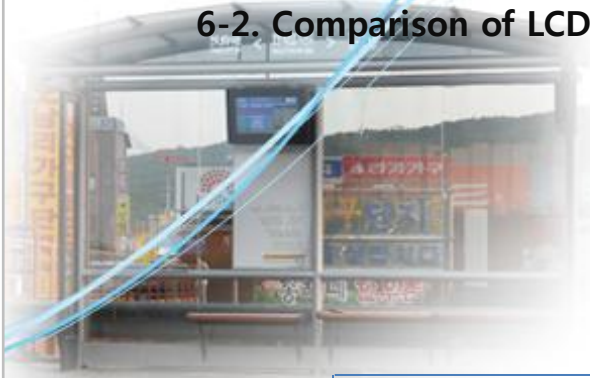

Sun light readable  
Installation Example



Sun Light Readable LCD

Normal LCD

# 6. Sun Light Readable LCD

Display Operation Division

Digital Signage

6. Sun Light Readable LCD

## 6-3. Development Status

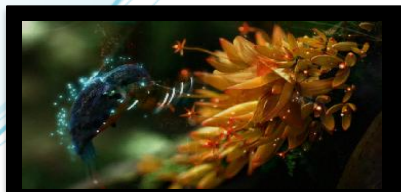

LCD Size	Brightness Change(cd/m2)	Status
	Normal → Tooling	
15.0"	450 → 1,000	Sample
32"	450 → 1,200	M.P.
46"	700 → 1,500	M.P.
70"	600 → 2,000	Sample

## 3-4-2) Comparison of Method

Comparison Item		Tooling Method				Comment
		Reflective Film	A/R Coating	Brightness Up	Optical Bonding	
Brightness	Day	◎	△	◎	△	
	Night	X	△	◎	△	
Outdoor Visibility		○	○	○	◎	
Contrast Ratio		○	○	○	◎	
Impact Resistance		△	△	△	◎	
Energy Efficiency		◎	△	X	△	

# 7. DPF TV

Display Operation Division

TV Solution

7. DPF TV

## 7-1. Introduction of DPF TV



With built-in set top box HD LCD TV,  
lead popularization of digital TV broadcast  
With beautiful and elegant design,  
while seeing TV not only provide best visual  
experiences but also harmonize with interior with  
smart outer frame

Can use suitably in various field as airport,  
subway station, wedding hall, hotel room,  
bank, hospital, department store, family restaurant,  
public institution, company, retail shop etc,  
especially need repeated publicity



# 7. DPF TV

Display Operation Division

TV Solution

7. DPF TV

## 7-2. 22" DPF TV Spec.



MODEL		SPECIFICATIONS
Display	LCD Size	22 inch TFT LCD
	Resolution	WSXGA+ (1680*1050)
	Brightness	300cd/m2
	Contrast Ratio	1000:1
	Response Time	Typical 5ms / Max 10ms
	Viewing Angle	160 degree (R/L, U/D)
External Link	Port	PC(RGB), Component, Composite, HDMI
	Memory	USB / SD Function (Each 1 Port)
Play	TV	NTSC / ATSC
	Image	JPG, DivX (DivX3.11/4.x/5.x data format)
	Audio	MP3
	Video	MPEG1~4, AVI
Others	Sound	Speaker built in (3W + 3W)
	Dimension	660(W) X 480 (H) X 90(T)
	Weight	8Kg

# 8. Mirror TV

Display Operation Division

TV Solution

8. Mirror TV

## 8-1. Mirror TV Solution

Realize measured interior design which is suitable to the various spaces with preceding design which trendsetters pursuit

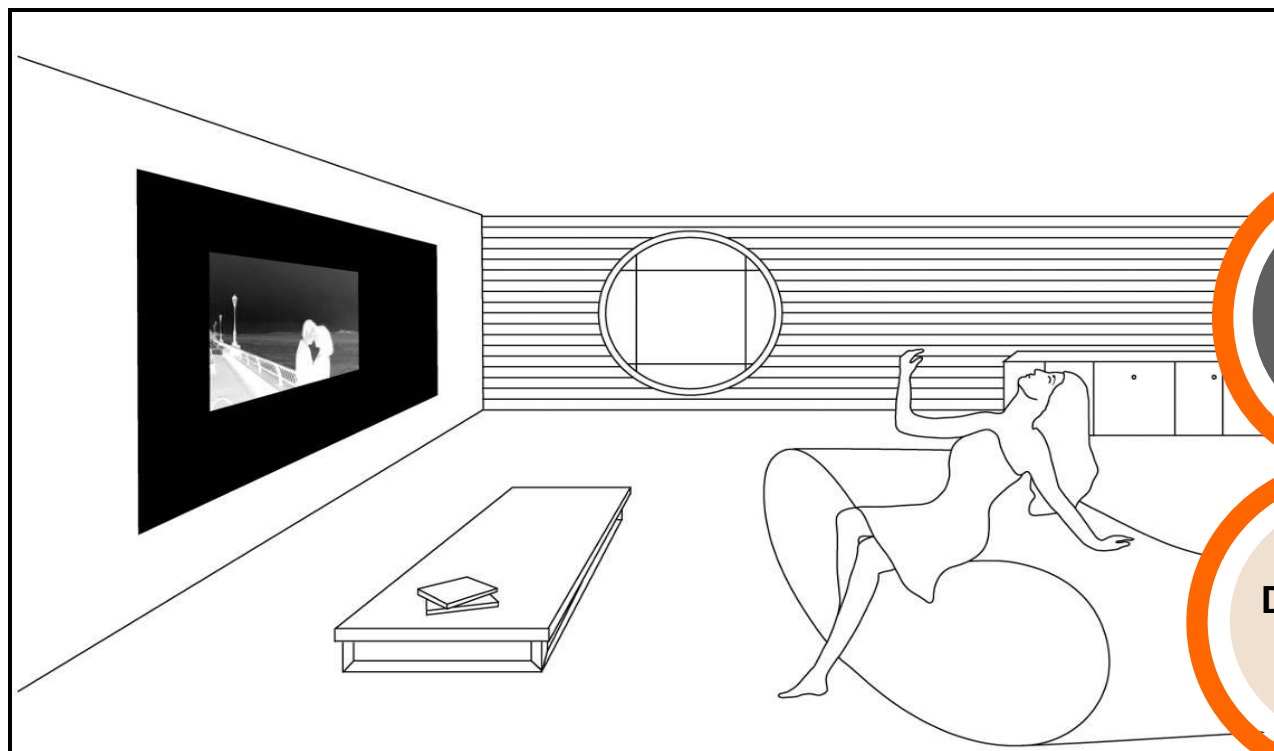

High End Display

Special Experience

Decorative Space

# 8. Mirror TV

Display Operation Division

TV Solution

8. Mirror TV

## 8-2. Mirror TV Application

- “In where you want !”

### Home

Bathroom



Dining room



Kitchen



Living room



Library



Bedroom



### Business / Commercial Area

Beauty shop



Restaurant



Hotel



Wait & Meet



Others



# 8. Mirror TV

Display Operation Division

TV Solution

8. Mirror TV

## 8-3. Mirror TV Specification

Model Name		15" TV Set	19" TV Set	22" TV Set	32" TV Set	37" TV Set	42" TV Set	47" TV Set	55" TV Set	
LCD	Display Size	15inch, 4:3	19inch, 16:10	22inch, 16:10	32inch, 16:9	37inch, 16:9	42inch, 16:9	47, 16:9	55inch, 16:9	
	Resolution	1024 X 768	1440 X 900	1680 X 1050	1920 X 1080					
	Number of Colors	16.7M colors (6-bit with A-FRC)	16.7M colors	16.7M colors	1.06B colors	1.06B colors	1.06B colors	1.07B colors	1.07B colors	
	Brightness	250 cd/m <sup>2</sup>	300 cd/m <sup>2</sup>	300 cd/m <sup>2</sup>	500 cd/m <sup>2</sup>	500 cd/m <sup>2</sup>	500 cd/m <sup>2</sup>	500 cd/m <sup>2</sup>	500 cd/m <sup>2</sup>	
	Contrast Ratio	800:1	1000:1		1300:1	1300:1	1300:1	1300:1	1300:1	
	Response Time	11ms	7.4ms	7.4ms	8ms					
	View Angle	R/L (140) , U/D (140)	R/L (160) , U/D (160)		R/L (178) , U/D (178)					
Audio / Video Port	Audio	3W(L) + 3W(R)			10W(L) + 10W(R)					
	PC	Analog RGB (D-SUB15)								
	HDMI	1Port				3Port				
	Component	YPbPr 1080i / 1080p								
	Video	CVBS(Composite Video), Input&Output / S-Video								
	TV	NTSC / ATSC								
Size	TV+Frame (W * H/mm)	450 * 410	540 * 430	600 * 480	1020 * 720	Depend on Install Place				
	Remocon	50 x 25 x 195								
Interface	Remocon	Infra Red Type								
Power		12V			100~240V,50/60Hz		Depend on Install Place			
Consumption		Max 35W	Max 45W	Max 55W	Max 200W	Depend on Install Place				

\* Products dimension and appearance are subject to change without notice for improvement.

# 9. Phodic

Display Operation Division  
 Digital Photo Frame  
 9. Phodic

## 9-1. 8" DPF Spec.



Item		SPECIFICATIONS
Display	Size / Resolution	8inch TFT LCD / 800X600
	Brightness	450cd/m2
Memory	Internal	512M / 1GB
	External	CF, SD, MMC, MS, MS Pro
File Play	Image	JPEG, AVI
	Music	MP3
External Link	M. Picture	MPEG1~4, AVI
Sound		Built in Speaker 1WX2

## 5-1-3) 8" DPF Dimension

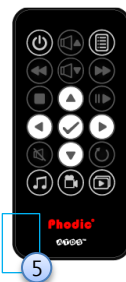
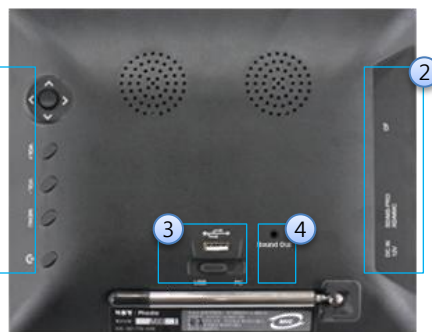
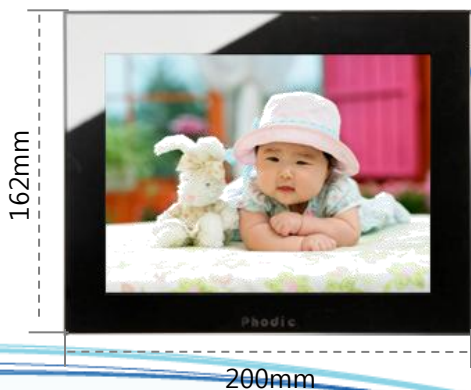

1. Jog/Shuttle Controller, Back, Options, Home, Power
2. CF card, SD/MS/MMC,
3. USB, PC
4. Sound Out
5. Remote control

# 9. Phodic Mini

Display Operation Division

Digital Photo Frame

9. Phodic Mini

## 9-2. Mobile Accessory 1.77"



Item	SPECIFICATIONS
LCD Size	1.77 inch TFT LCD
Resolution	QQVGA (128X160)
Brightness	200cd/m2
Internal Memory	16MB Internal Memory
Image	JPEG, BMP Photo Viewer
Power	Lithium-ion Battery

- As brand new product MP schedule is September,
- Specifications are subject to change without notice

## 5-2-1) Mobile Accessory 2.83"



# 9. Wi-Fi DPF

Display Operation Division

Digital Photo Frame

9. Wi-Fi DPF

## 9-3. Wi-Fi DPF(HDTV-Option)



- 2009 New Design Concept
- Real Premium LCD TV(option)
- Photo HD



***KNL Global Co., LTD***

**801 River Tower B/D, Yeoudo-Dong, Yeongdeungpo-Gu, Seoul Korea**

**TEL : 82-2-3667-2220/2235~7 FAX :82-2-3667-2221**

**General Manager / Oversea Operation**

**Terry Jung (Mobile : 82-10-9049-9446)**

**[hsterryjung@gmail.com](mailto:hsterryjung@gmail.com)**



**Thank You**